

Solar Street Light

Y series

Solar Street Light YY series

Solar Street Light YP series

Solar Street Light YH series



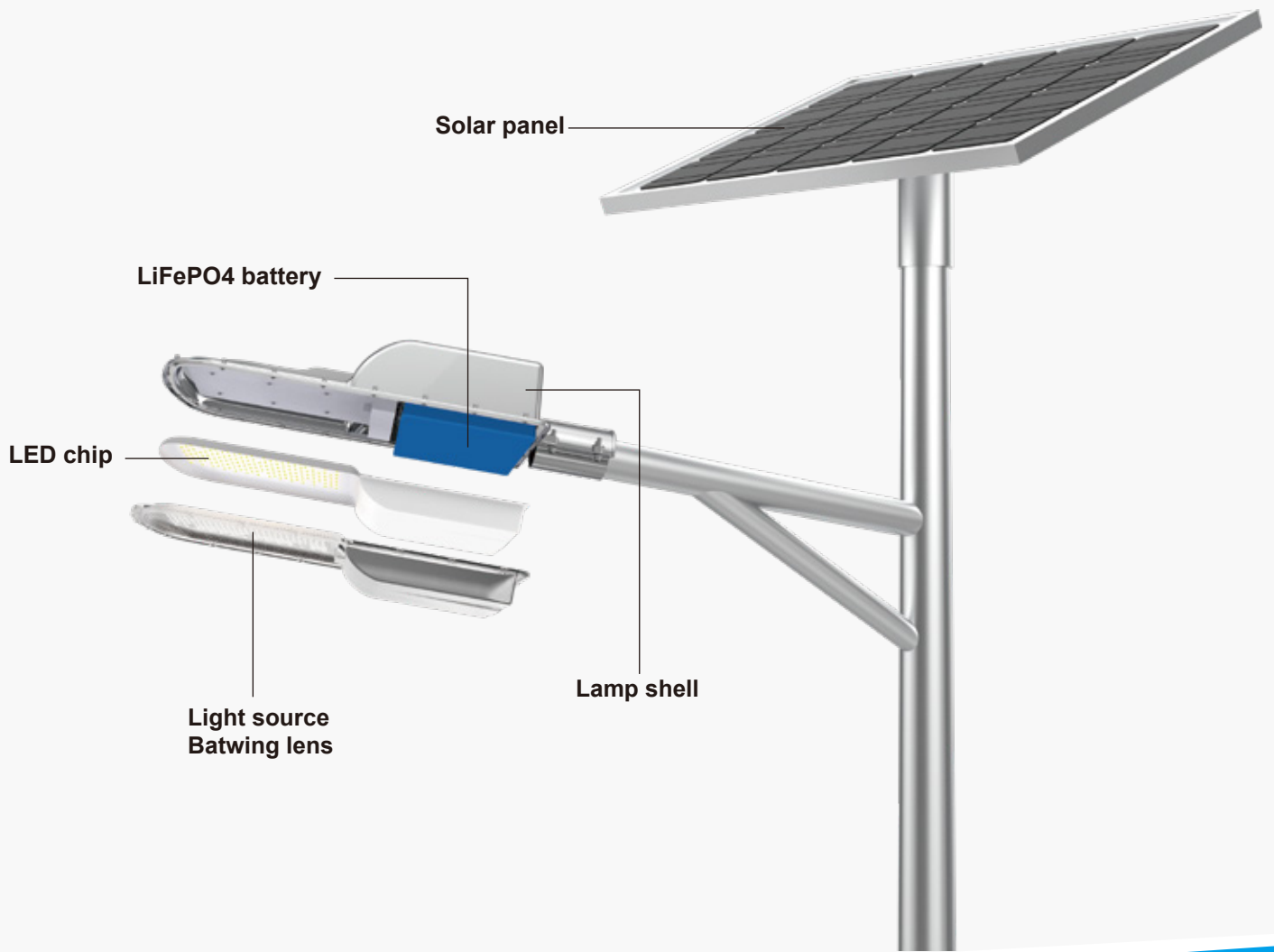

All in two structure is easy to transport, install and maintain



YP series



YY series



YH series



Light Efficiency Management

Multiple led chip work simultaneously, the whole system light efficiency has been improved to 160lm/w.



Charge and Discharge Management

Protect battery by software and hardware, more than 2000 time's cycles.



IPC 5.0 Technology

Five-stage intelligent power,intelligent algorithm to achieve perfect balance of brightness and discharge time.



Patent Bat-wing Lens

Lighting area much wider, the maximum of using the lighting all light the road.



Intelligent power control

Judge recent climate plan the reasonable discharge power.



Battery Power indicator

To check lamp's charge and discharge conveniently.

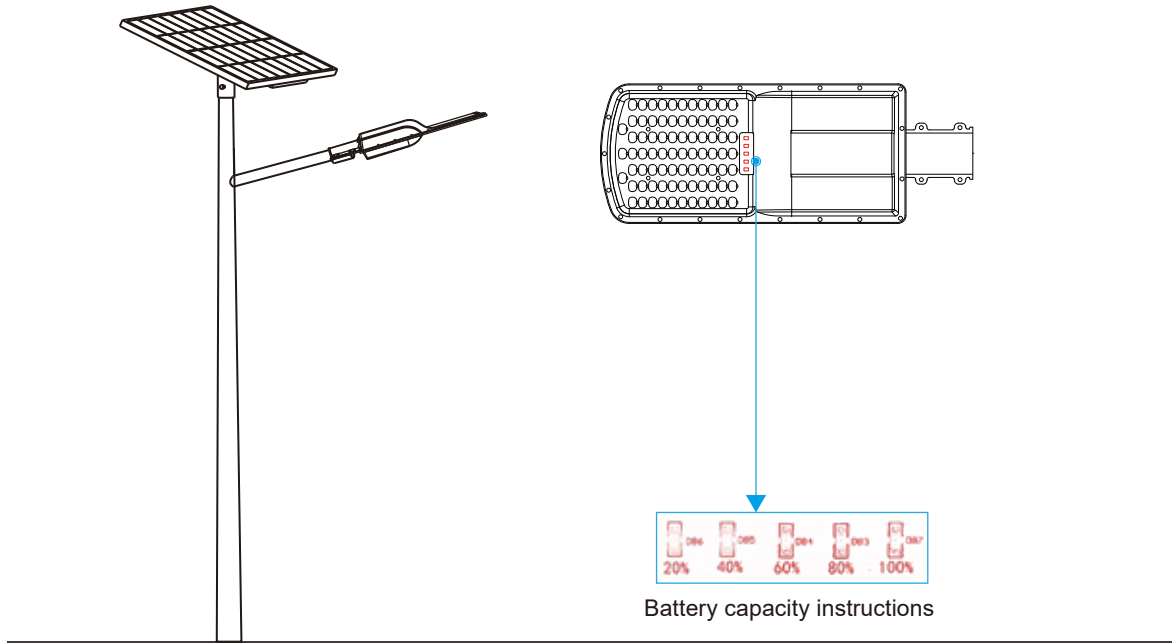

Battery Indicator

Indicator light status instructions

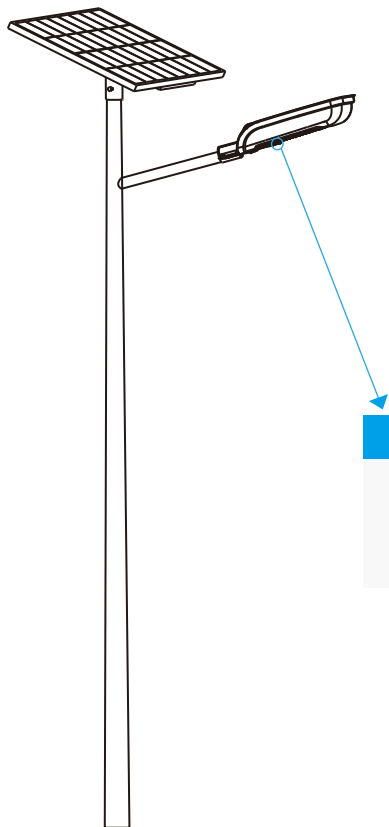

YP-150/YP-200





LED	Status	Instruction content
 Red 	Long-term On	Discharge or waiting for charge
	Slow twinkling	Charging
	Fast twinkling	Battery over charge or over discharge

Indicator light status instructions

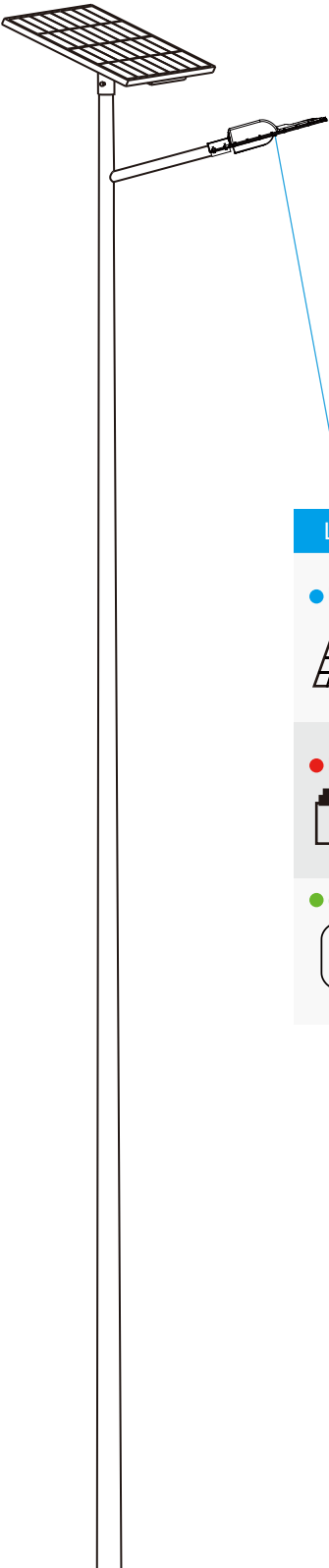
Solar Street Light YH series there are three indicator lights







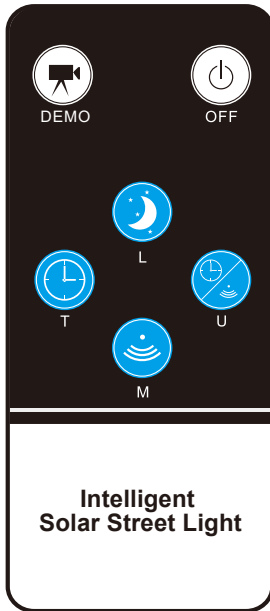

LED	Indications	Status	Functions
● Blue 	Charging indication	Long-term On	Be charging
		Long-term Off	Battery full charged
● Red 	Battery indication	Long-term On	Battery works normally
		Long-term Off	Battery is not connected/No power
		Fast twinkling	Battery is over discharged
	Slow twinkling	Battery full charged	
● Green 	Load indication	Long-term On	Load is on
		Long-term Off	Load is off

Remote Control

6 working modes



-  **DEMO:** No matter day or night, light "on" for 1 minute. Only for test use
-  **OFF:** Light "off", no matter day or night
-  **L:** 100%-2hrs, 60%-3hrs, 20%-dawn
-  **T:** At night, 100%-3hr, 50%-3hrs, 30%-2hrs:
-  **M:** At night, 100%-3hrs, 50%-3hrs
-  **U:** At night, 100%-3hrs, 50%-3hrs(Highlight mode)

Solar Street Light YY series L mode:

L: At night, 100%-3 hrs, 50%-2 hrs, 20%-dawn

Note:

- 1、 Default is L mode, once a certain mode was set successfully, it will be reserved until you change other modes with remote control.
- 2、 U Highlight mode: Increase 30% on the original basis, mean 3H-130%, 3H-80%.

Light Distribution

Luminous intensity distribution curves

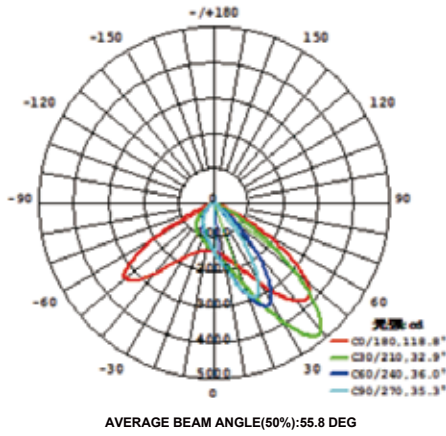

YY series

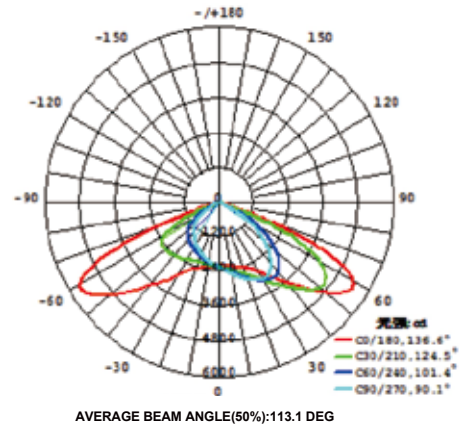

YP series

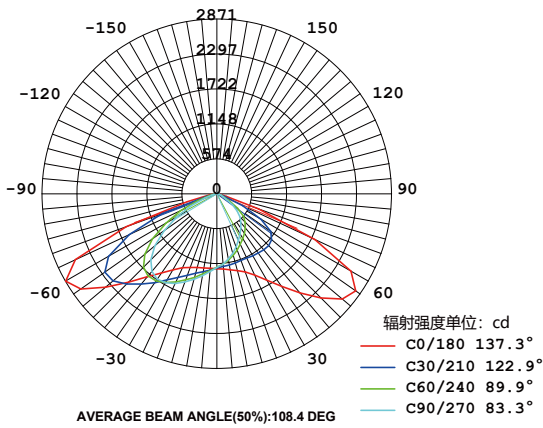

YH series

Bat wing lens with polarized light

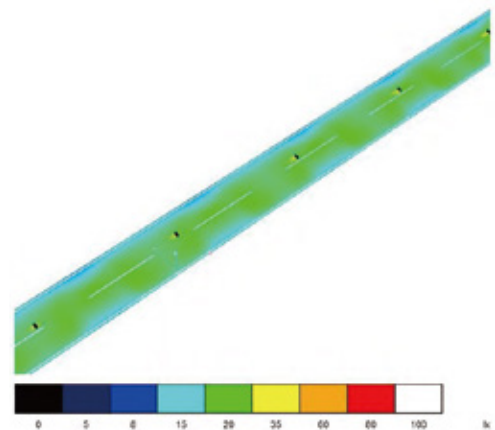
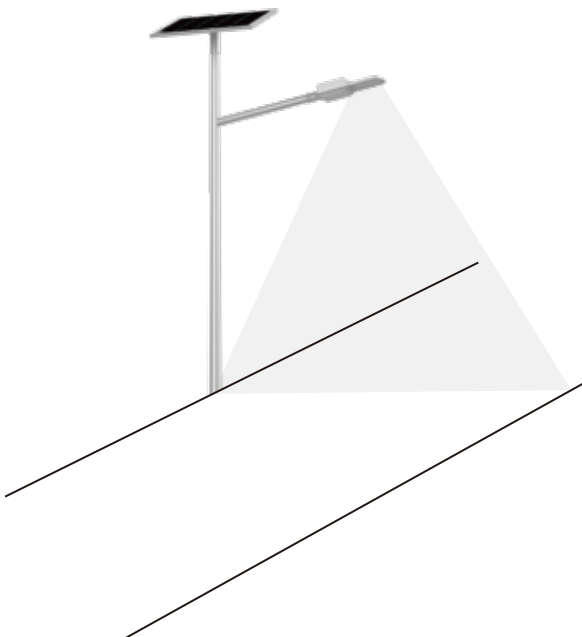

Dimension

lamp head

YY-80、YY-100

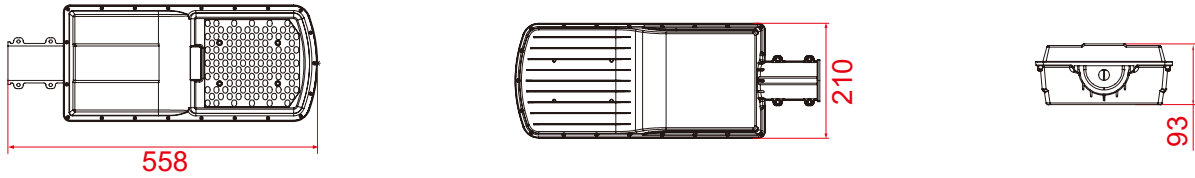

YP-150、YP-200-A、YP-200

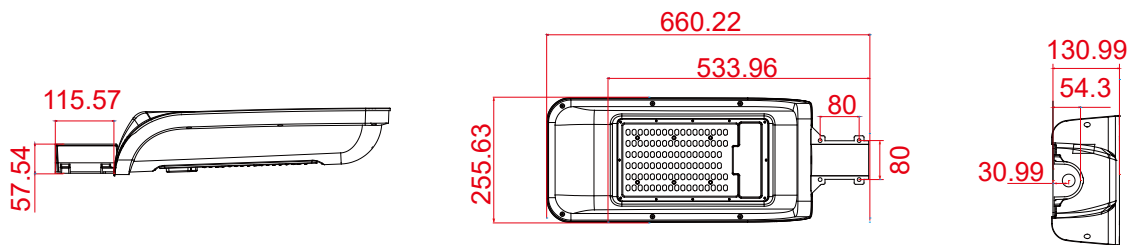

YH-100、YH-120

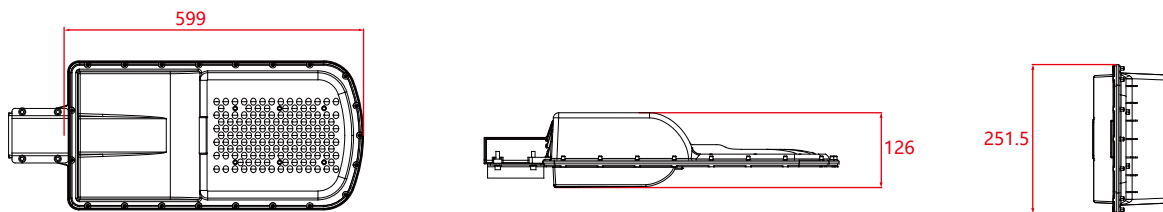

Solar panel

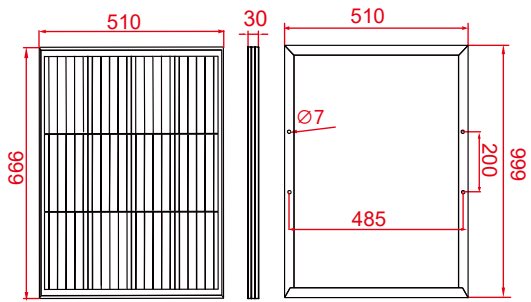

60W

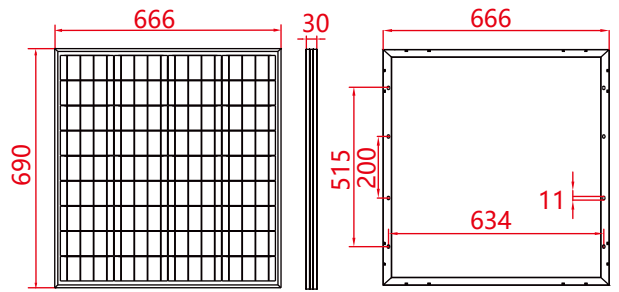

70W

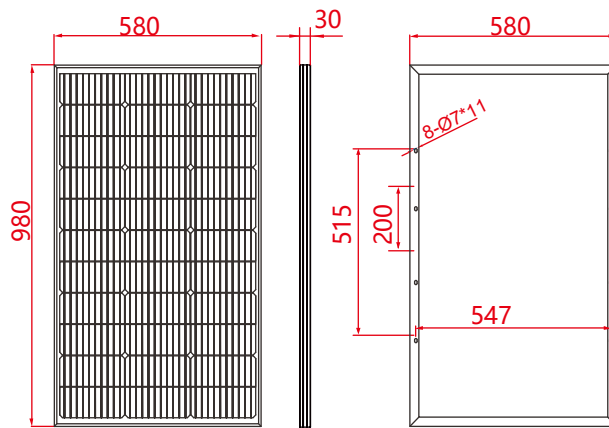

100W

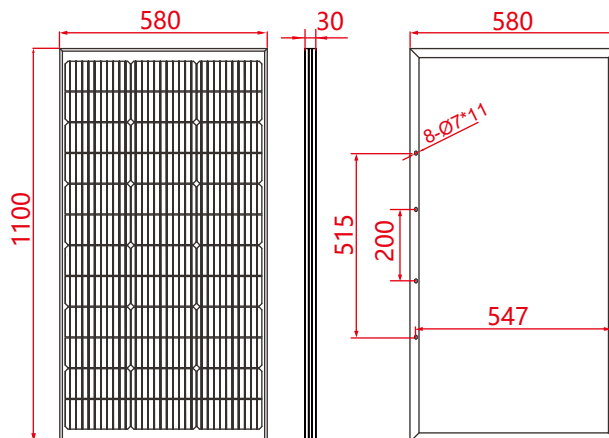

120W

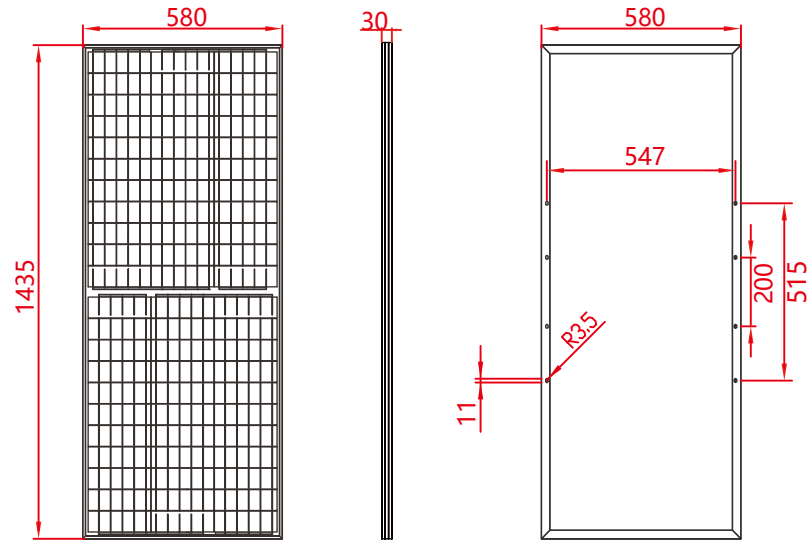

150W

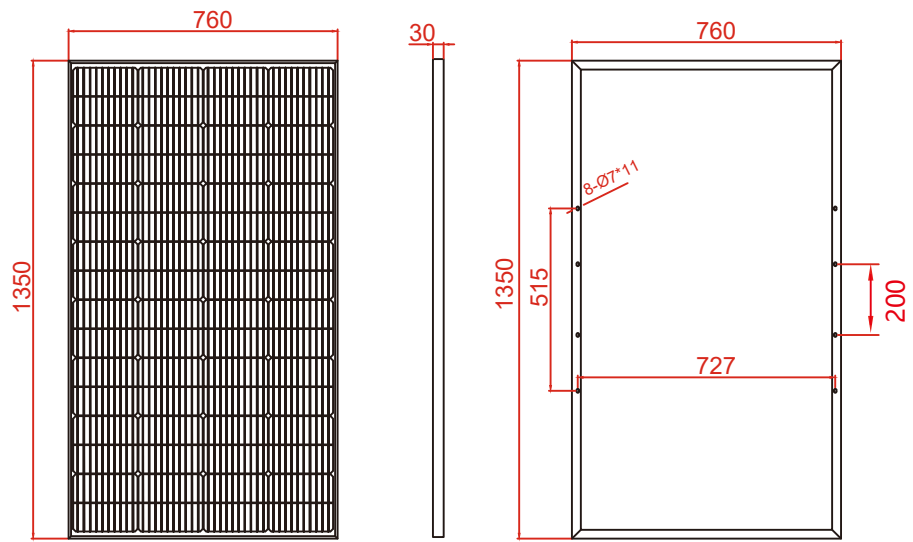

200W

Parameter

Technical parameter

Type	YY-80	YY-100	YH-100	YH-120	YP-150	YP-200-A	YP-200
Lamp head							
Light output	20W	30W	40W	50W	60W	70W	70W
LED chip	120pcs			140pcs		140pcs(5050)	
Luminous flux	3400lm	4800lm	6400lm	8000lm	9600lm	12800lm	12800lm
Beam angle	150°*70°			155°*55°		160°*45°	
Lifespan	50000hrs						
IP Rating	IP65						
Working temperature	-20°C~60°C						
Color temperature	6000-7500K						
CRI	Ra≥70						
SOLAR PANEL							
Power	60W	70W	100W	120W	150W	150W	200W
Voltage	6V			18V			
Solar cell efficiency	17%-18%			19%-20%			
Material	Polycrystalline silicon			Monocry stalline silicon			
BATTERY							
Capacity	192WH	256WH	320WH	384WH	576WH	640WH	640WH
Lighting time(full charged)	5-7 rainy days						
Lithium battery	LiFePO4						
INSTALLATION							
Top diameter of pole	60 mm						
Mounting height	7-8M			8-10M			
Installation spacing	20-40M						

Application

